

## Dual Common-Cathode Ultrafast Plastic Rectifier

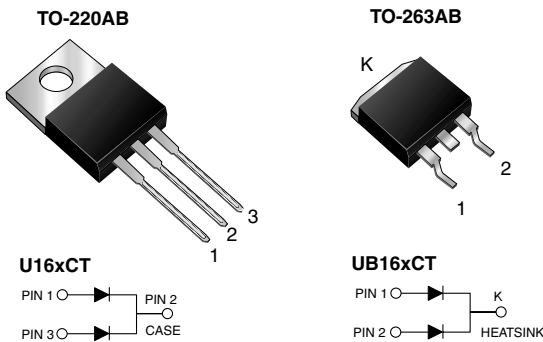

### FEATURES

- Oxide planar chip junction
- Ultrafast recovery time
- Soft recovery characteristics
- Low switching losses, high efficiency
- High forward surge capability
- Meets MSL level 1, per J-STD-020, LF maximum peak of 245 °C (for TO-263AB package)
- Solder dip 260 °C, 40 s (for TO-220AB package)
- Component in accordance to RoHS 2002/95/EC and WEEE 2002/96/EC



**RoHS**  
COMPLIANT

### TYPICAL APPLICATIONS

For use in low voltage, high frequency rectifier of switching power supplies, freewheeling diodes, dc-to-dc converters or polarity protection specifically for DCM application.

### MECHANICAL DATA

**Case:** TO-220AB and TO-263AB

Epoxy meets UL 94V-0 flammability rating

**Terminals:** Matte tin plated leads, solderable per J-STD-002 and JESD22-B102

E3 suffix for consumer grade, meets JESD 201 class 1A whisker test

**Polarity:** As marked

**Mounting Torque:** 10 in-lbs maximum

PRIMARY CHARACTERISTICS	
$I_{F(AV)}$	8 A x 2
$V_{RRM}$	100 V, 150 V, 200 V
$I_{FSM}$	80 A
$t_{tr}$	35 ns
$V_F$ at $I_F = 8$ A	0.87 V
$T_J$ max.	150 °C

MAXIMUM RATINGS ( $T_C = 25$ °C unless otherwise noted)					
PARAMETER	SYMBOL	U(B)16BCT	U(B)16CCT	U(B)16DCT	UNIT
Maximum repetitive peak reverse voltage	$V_{RRM}$	100	150	200	V
Max. average forward rectified current (Fig. 1)	$I_{F(AV)}$	16 8			A
Peak forward surge current 8.3 ms single half sine-wave superimposed on rated load per diode	$I_{FSM}$	80			A
Electrostatic discharge capacitor voltage, human body model: C = 150 pF, R = 1.5 k $\Omega$ (contact mode)	$V_C$	8			kV
Operating junction and storage temperature range	$T_J, T_{STG}$	- 55 to + 150			°C



ELECTRICAL CHARACTERISTICS (T <sub>C</sub> = 25 °C unless otherwise noted)						
PARAMETER	TEST CONDITIONS		SYMBOL	TYP.	MAX.	UNIT
Instantaneous forward voltage per diode <sup>(1)</sup>	I <sub>F</sub> = 4 A I <sub>F</sub> = 8 A	T <sub>J</sub> = 25 °C	V <sub>F</sub>	0.90 0.99	- 1.10	V
	I <sub>F</sub> = 4 A I <sub>F</sub> = 8 A	T <sub>J</sub> = 125 °C		0.77 0.87	- 0.95	
Reverse current per diode <sup>(2)</sup>	rated V <sub>R</sub>	T <sub>J</sub> = 25 °C T <sub>J</sub> = 125 °C	I <sub>R</sub>	0.5 155	10 600	μA
Reverse recovery time per diode	I <sub>F</sub> = 0.5 A, I <sub>R</sub> = 1.0 A, I <sub>rr</sub> = 0.25 A		t <sub>rr</sub>	28	35	ns
Reverse recovery time per diode	I <sub>F</sub> = 8 A, di/dt = 20 A/μs, V <sub>R</sub> = 200 V, I <sub>rr</sub> = 0.1 I <sub>RM</sub>		t <sub>rr</sub>	67	80	ns
Stored charge per diode			Q <sub>rr</sub>	33	-	nC
Forward recovery time per diode	I <sub>F</sub> = 8 A, di/dt = 64 A/μs,		t <sub>fr</sub>	160	-	ns
Peak forward voltage per diode	V <sub>F</sub> = 1.1 x V <sub>F</sub> max.		V <sub>FP</sub>	3.3	-	V

**Notes:**

(1) Pulse test: 300 μs pulse width, 1 % duty cycle

(2) Pulse test: Pulse width ≤ 40 ms

THERMAL CHARACTERISTICS (T <sub>C</sub> = 25 °C unless otherwise noted)				
PARAMETER	SYMBOL	U16xCT	UB16xCT	UNIT
Typical thermal resistance per diode	R <sub>θJC</sub>	3.5		°C/W

ORDERING INFORMATION (Example)					
PACKAGE	PREFERRED P/N	UNIT WEIGHT	PACKAGE CODE	BASE QUANTITY	DELIVERY MODE
TO-220AB	U16DCT-E3/4W	1.87	4W	50/tube	Tube
TO-263AB	UB16DCT-E3/4W	1.31	4W	50/tube	Tube
TO-263AB	UB16DCT-E3/8W	1.31	8W	800/reel	Tape and reel

**RATINGS AND CHARACTERISTICS CURVES**

(T<sub>A</sub> = 25 °C unless otherwise noted)

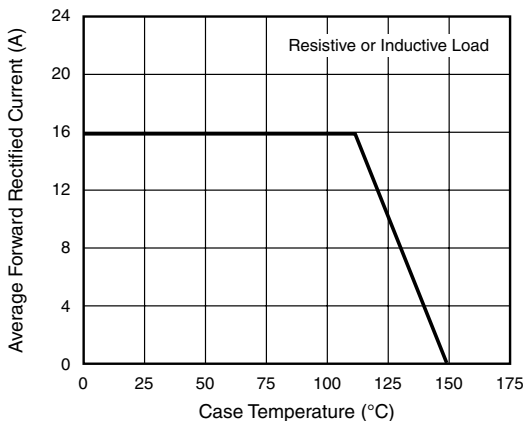

Figure 1. Maximum Forward Current Derating Curve

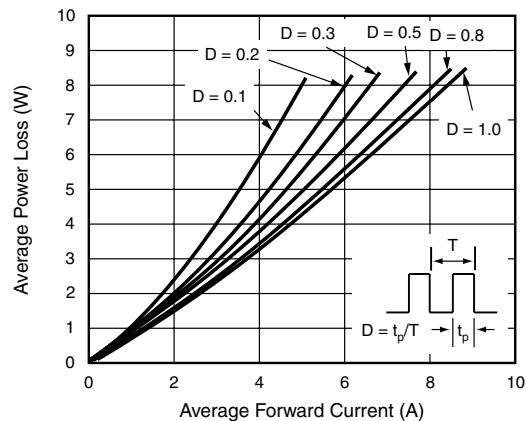

Figure 2. Forward Power Loss Characteristics Per Diode

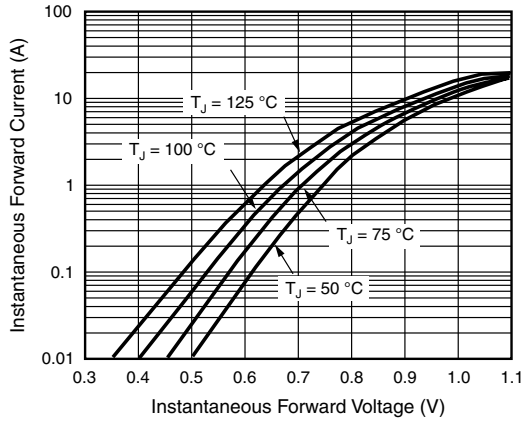

Figure 3. Typical Instantaneous Forward Characteristics Per Diode

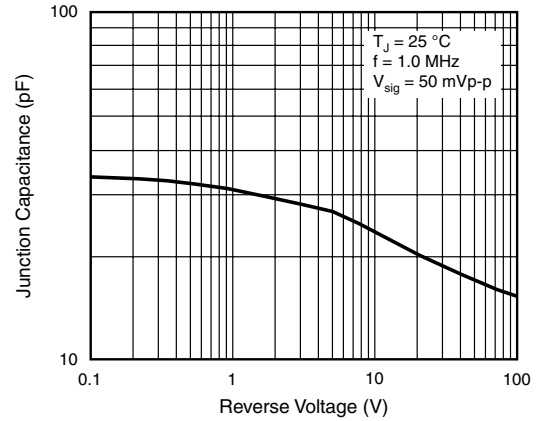

Figure 5. Typical Junction Capacitance Per Diode

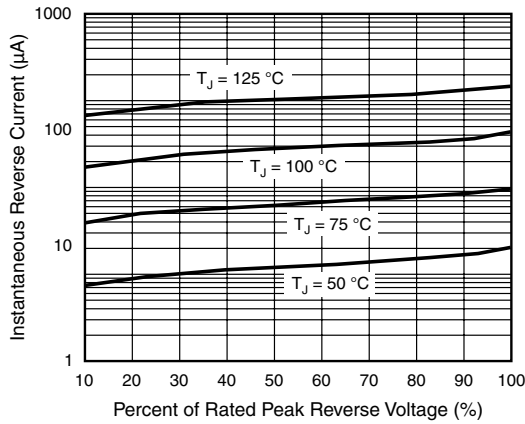

Figure 4. Typical Reverse Characteristics Per Diode

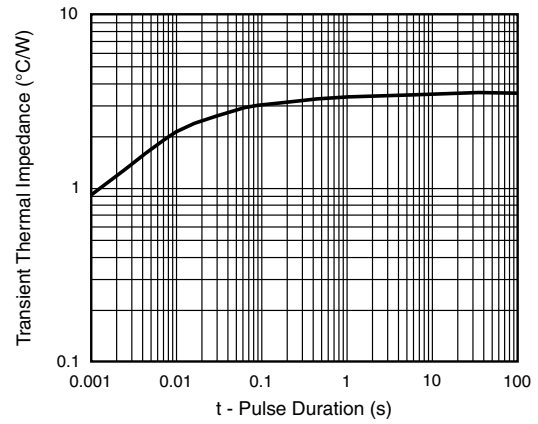

Figure 6. Typical Junction Capacitance Per Diode

# U(B)16BCT thru U(B)16DCT

New Product

Vishay General Semiconductor



## PACKAGE OUTLINE DIMENSIONS in inches (millimeters)

### TO-220AB

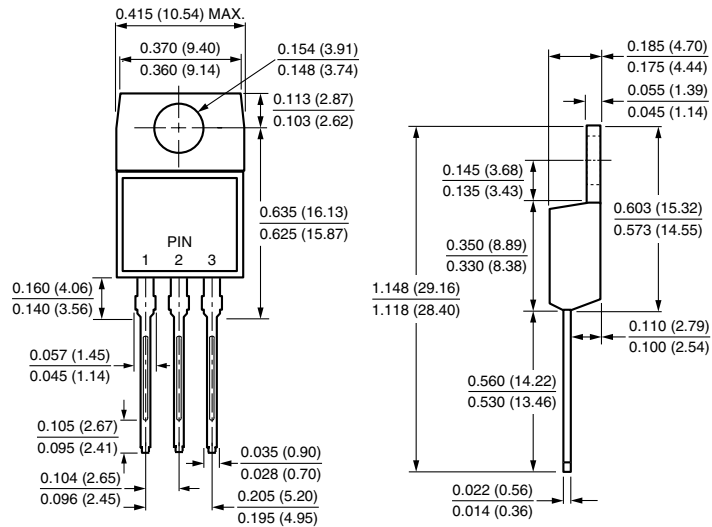

### TO-263AB

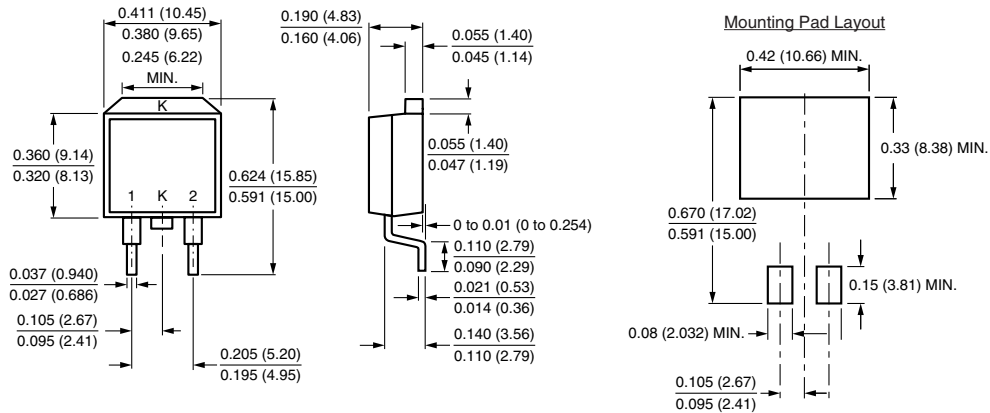



## Disclaimer

All product specifications and data are subject to change without notice.

Vishay Intertechnology, Inc., its affiliates, agents, and employees, and all persons acting on its or their behalf (collectively, "Vishay"), disclaim any and all liability for any errors, inaccuracies or incompleteness contained herein or in any other disclosure relating to any product.

Vishay disclaims any and all liability arising out of the use or application of any product described herein or of any information provided herein to the maximum extent permitted by law. The product specifications do not expand or otherwise modify Vishay's terms and conditions of purchase, including but not limited to the warranty expressed therein, which apply to these products.

No license, express or implied, by estoppel or otherwise, to any intellectual property rights is granted by this document or by any conduct of Vishay.

The products shown herein are not designed for use in medical, life-saving, or life-sustaining applications unless otherwise expressly indicated. Customers using or selling Vishay products not expressly indicated for use in such applications do so entirely at their own risk and agree to fully indemnify Vishay for any damages arising or resulting from such use or sale. Please contact authorized Vishay personnel to obtain written terms and conditions regarding products designed for such applications.

Product names and markings noted herein may be trademarks of their respective owners.